

PLR350
Reference & Maintenance Manual



**32114 Mallard Ave.
PO Box 409
Tangent, OR 97389-0409
U.S.A.**

Phone: [541] 791-9678
Fax: [541] 791-9410
Toll Free: [888] 754-3111
Web: www.primatics.com
E-mail: info@primatics.com



**PLR350 Manual
Revision Information**

Publication Date	Notes
Jan 2015	Revised for PLR350 only, new logo

Notice: The descriptions, drawings, and specifications contained herein are subject to change. Primatics is not responsible for errors or omissions herein or for incidental damages in connection with the furnishing or use of this information. This document shall not be reproduced, photocopied, or duplicated, in whole or in part, without prior written approval of Primatics Corporation.

For Specifications, Dimensioned Drawings and additional information, refer to the PLR Datasheet available from our website at www.primatics.com.

©Copyright 2015 by Primatics, Inc; All Rights Reserved. Primatics, the Primatics logo, PrimaFlex, PrimaSeal & SimpleMatch are trademarks of Primatics, Inc.

PLR350 Manual Revision Information	2
1) Overview	4
2) Introduction – About the PLR350	5
2.1) About the PLR Encoder	6
3) Model Configuration	7
 4) Personal Safety 	8
5) Stage & Manual Conventions	9
5.1) Direction of Motion	9
5.2) Units of Measure	9
6) Installation Preparations	10
6.1) Heat and Humidity.....	10
6.2) Contamination	10
6.3) Electrical Noise	11
7) Installing the PLR Positioning Stage	12
7.1) Tools you will need.....	12
7.2) Unpacking	12
7.3) Mounting surface preparation	12
7.4) Electrical Connections.....	13
7.4.1) Color Codes for Pigtailed Cable.....	16
7.4.2) Hall Effect Commutation Sequence	17
7.5) Home and Limit Sensors.....	17
7.5.1) Home Options:	18
7.5.3) Limit Sensors and Reference Index.....	19
7.6) Recommended System Test.....	19
8) Preventive Maintenance	20
8.1) Lubrication.....	20
9) Troubleshooting & Service	21
9.1) Troubleshooting Help	21
9.2) Service	21

1) Overview

This user guide is designed to help you install and maintain your PLR Series rotary positioning stage application. Follow these steps to ensure correct stage installation and maximum stage life:

- Step 1* Review this entire user manual. Become familiar with all installation procedures prior to integrating your system.
- Step 2* Review the safety summary to develop an understanding of standard safety practices when installing and operating automated equipment.
- Step 3* Familiarize yourself with the conventions summary.
- Step 4* Review installation procedures. For best results, follow these procedures carefully.
- Step 5* Once you successfully complete all the installation procedures, you will be ready to install and operate your stage.
- Step 6* Review preventive maintenance section for proper lubrication schedule.

2) Introduction – About the PLR350

The PLR350 positioning stage is designed for precision rotary movement. It offers a variety of options for systems in need of small, stiff angular corrections. Precision cross roller bearings support the rotating platen, delivering high capacity, excellent rigidity and long life. Our unique tangential drive system uses a precision grade ballscrew that avoids premature wear and backlash.

The PLR Series is available in 2 basic models: PLR190 and PLR350. These differ by size and load capacity.

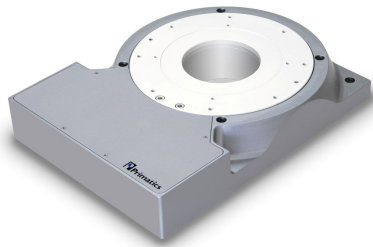

PLR190

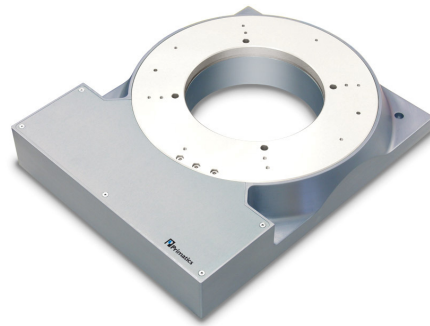

PLR350

Many customers choose the Primatics Motion Drive Chassis (MDC) to power PLR stages. The MDC is a modular system that packages motor drivers, encoder interfaces, power supplies and safety systems into a single chassis. It acts as an intermediary between a Galil Optima, National Instruments 7344 or Delta Tau PMAC II motion control cards and a Primatics positioning stage. Pre-wired high-flex cables are available to allow a convenient connection from the stage to the MDC chassis. The MDC drive chassis interfaces 3rd party controllers via a removable interconnect module. These interconnect modules conform to each manufacturer's interconnect cable, and internally route all the command and I/O signals.

Optionally, a Primatics positioning stage can be used with many third party controller and amplifier systems. In this case, a pigtailed cable is available to simplify the connection between the PLR stage and controls.

2.1) About the PLR Encoder

The encoder ratio for each stage is determined through a calibration process. A "master encoder" is attached to the stage and the encoder ratio for the stage is determined. This ratio is used when measuring the stage accuracy/repeatability. The ratio is reported in the calibration results delivered with each PLR.

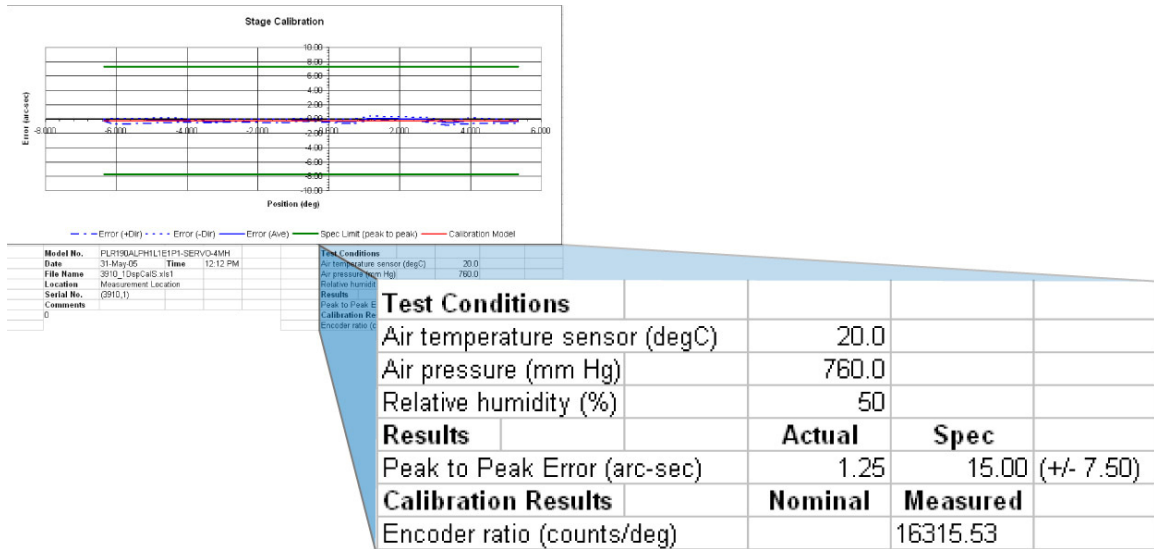

Figure 2-1) Sample laser plot with test results

Figure 2-1 shows the test results of a PLR190 with an E1 Encoder option. The nominal encoder resolution reported on the specification sheet is 0.22 arc-sec/count. In calibration, the measured encoder ratio was 16315.53 counts/degree. This yields a resolution of 0.22065 arc-sec per count.

3) Model Configuration

SAMPLE MODEL NUMBER:

PLR350 AL P E1 H1 L1 M1 P1

- Model Series**
Limited Rotation PLR350
- Base Material**
Aluminum AL
- Grade**
Precision P
- Encoder¹**
0.12 arc-second Output, 0.45 arc-second Drive E1
- Home Sensor**
Normally Closed H1
Normally Open H2
- Limit Sensor**
Normally Closed L1
Normally Open L2
- Drive Type**
Brushless Servo Motor M1
- Protection Level**
Level 1 - Hard Covers P1

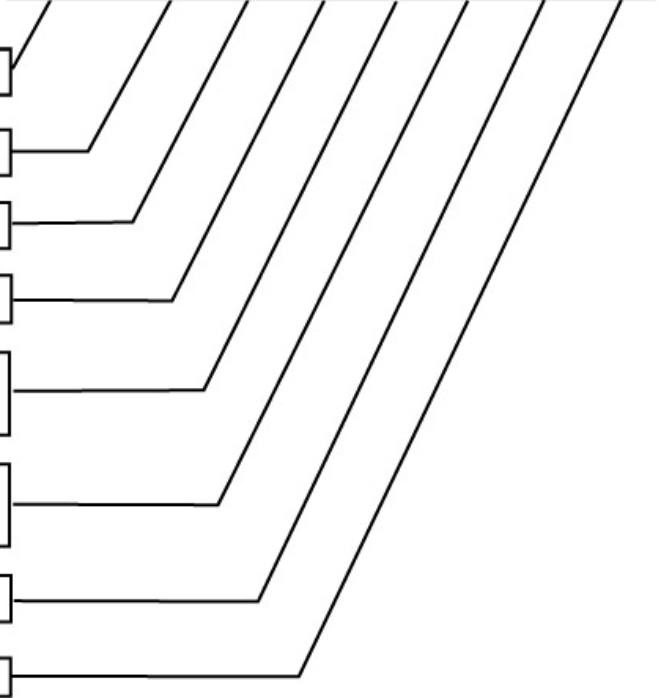

¹The output encoder directly reads the rotary position. The drive encoder is on the motor drive and is used for motor velocity feedback for dual-loop positioning control.

4) Personal Safety

Please review before installing your positioning stage

Observe common industrial safety practices when installing and operating automated equipment.

- Have power connections made by qualified personnel.
- Keep fingers and other items out of any opening in the stage while it is in operation since injury or damage may result.
- Provide a safe access route and adequate room for servicing.
- Perform the recommended periodic maintenance described in this document.
- Verify that the work envelope is free of obstructions before the positioning stage is powered.
- Insure that you have the feedback wired properly to the controller before applying power to the positioning stage. Improper feedback connections can cause a motor run-away condition that has the potential to damage the stage and injure an operator.
- Only trained operators of the positioning stage should be allowed near the work environment.
- If so equipped, identify emergency stop circuits and actuators in the workcell.
- Note the places in the workcell where pinch points occur, and provide adequate safety clearance or safety curtain.
- Never operate the motor in a location that could be splashed by water, exposed to corrosive or flammable gases or is near combustible substances since this may cause an electric shock, fire or malfunction.
- Never touch the motor, driver, or peripheral devices when the power is on or immediately after the power is turned off. The high temperature of these parts may cause burns.

5) Stage & Manual Conventions

5.1) Direction of Motion

The positive direction of motion is defined as a rotation in the counter clockwise direction as one is looking down on the stage platen. The encoder is wired so that the encoder count increases as the stage rotates in the positive direction. Figure 4-1 illustrates this convention.

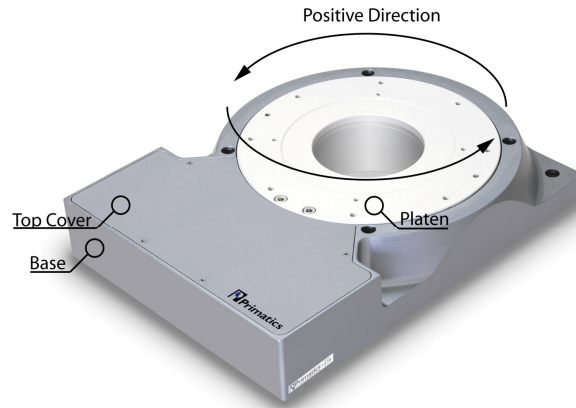

Figure 5-1: PLR350 Conventions

5.2) Units of Measure

Primatics uses the metric system for all specifications and dimensions. All linear dimensions are specified in millimeters. Angular displacement is specified in degrees. Accuracy error and repeatability for the PLR is expressed in arc-seconds (1 degree = 3600 arc-seconds). Load capacity is specified in kilograms and moment capacity is given in Newton-meters. All torque specifications are given in Newton-meters. Thrust specifications are given in Newtons.

The following table gives some common conversions into English units:

Metric Unit	English Unit
1 Kilogram equals	0.0685 slug*
1 micron equals	0.0000394 inch
1 millimeter equals	0.0394 inch
1 Newton-meter equals	8.85 in-lbs
1 Newton equals	0.2248 lbs
*1 Kg has a weight of 2.205 lb when $g = 9.8 \text{ m} / \text{s}^2$	

6) Installation Preparations

This section outlines installation environments. Unfavorable installation conditions may cause electric shock, fire, or breakdown. Certain breakdown situations or malfunctions in particular may lead to serious injury or other consequences. Assure that the unit is used under the following installation conditions:

- Indoors, free from being splashed by water
- No corrosive or inflammable gases present
- Well ventilated place, minimum level of dust or waste
- An environmental temperature range between 0-40°C, and humidity between 20-80% RH (location with no condensation) Note - These values show the range in which operation can be carried out safely, but not the environmental range in which stage accuracy can be guaranteed. Stage accuracy can be guaranteed at 20°C +/- 1°C
- Location should not be affected by electrical noise.
- Location should be where inspection and cleaning can be performed without difficulty.

6.1) Heat and Humidity

All positioning stages are assembled and tested at 20°C. Any stage calibrations are also performed at 20°C. For optimum accuracy the ambient temperature should be maintained at 20°C. Deviations from this nominal temperature may result in degraded accuracy performance.

Ballscrew driven stages are susceptible to thermal expansion effects. The ballscrew nut can create a localized thermal gradient if driven at high speeds. Airflow through the stage can help minimize ballnut heating.

6.2) Contamination

Applications in contaminated environments require the electrical, optical and mechanical components to be protected. The standard lip seal protection and high pressure (60-120psi)/low flow air purge system is sufficient for environments generating moderate quantities of 0.25mm and larger particles. Additional protection must be designed for stages that will be splashed with fluids.

Airflow through a stage must be filtered and dry. The filtration system should reject particles larger than 2 microns. Air pressures between 60-100 psi are sufficient for convection cooling. A typical air source can be made suitable with the addition of an inline desiccant dryer and filter/regulator assembly. Humidity should be less than 85% and there should be no condensation in the environment the stage is used in.

6.3) Electrical Noise

Electrical noise is the corruption of signals carried over low voltage wires. Encoder signals can be corrupted resulting in spurious encoder counts thus causing the stage to drift. Grounding, shielding, and spatial separation are all countermeasures to reduce the influences of electrical noise on performance. You can minimize the potential for electrical noise by observing the following installation precautions:

- Physically separate low voltage conductors from those carrying high voltage.
- Ensure that all components are properly grounded.
- Ensure that all wiring is properly shielded.

7) Installing the PLR Positioning Stage

7.1) Tools you will need

The PLR Series use the following fasteners:

	Mounting Holes in Base	Rotating Platen	Cover Screws
PLR350	M5 & M6 SHCS	M4 & M5	Phillips

7.2) Unpacking

Carefully remove the stage from its shipping crate and inspect it for evidence of shipping damage. Report any damage immediately to your authorized dealer.

Improper handling of the stage may degrade its performance. Follow these guidelines when handling and mounting your stage.

- 1) Do not drop the stage onto its mounting surface. Place the stage gently on the mounting surface. Impact loads can cause high spots on mounting surfaces, misalignment of drive components and warping of the base.
- 2) Do not drill holes into the stage. If additional holes are necessary, contact your local distributor.
- 3) Lift the stage by its base structure only.
- 4) Stage disassembly and alteration, unless specified otherwise, may void warranty.

7.3) Mounting surface preparation

The characteristics of the surface the positioning stage is mounted to will have a large effect on system performance. An accurate and flat positioning stage will conform to the shape of its mounting surface, therefore a flat mounting surface is required. In the absence of a sufficiently flat surface, a three point mounting scheme can be utilized to rely on the inherent flatness of the stage. This technique can introduce negative dynamic effects in moment load applications because a large portion of the stage base is not in contact with the mounting surface. The flatness and straightness specifications can be affected under large loads. For best results in maintaining stage specifications we suggest the following:

- 1) Use a laboratory Grade AA granite surface plate
- 2) Before mounting stage, inspect for burrs or dings on the stage mounting surfaces
- 3) Clean all mounting surfaces with acetone

In the absence of a granite surface plate, we recommend a base plate made of the same material as the base of the stage. A mounting surface constructed out of a material different from the stage base material can introduce warping in the stage in the presence

of a thermal gradient. The surface flatness should match the requirements of the application; a good starting point is to have the mounting surface flat to less than 5-8 μ m.

7.4) Electrical Connections

All PLR models are terminated with a 450mm flexible cable with a 28 position circular connector on the end. The pin-out of the connector is dependent on the motor option. See Table 7-1 for servo motors and 7-2 for stepper motors. Models configured with a secondary encoder on the drivetrain include an encoder cable (see Table 7-3).

A popular option for applications not using the Primatics MDC drive chassis is the pigtailed extension cable. This is similar to the extension cable used to connect a stage to the MDC drive chassis, except the end that connects to the drive is un-terminated for easy connection to a user-supplied motion controller. Section 7.4.1 shows the conductor assignments for this cable.

Table 7-1: Servo Axis Connector (Motor, encoder, limits, home, temp)
 FCI circular connector, 28 pins, size 20 shell

Pin	Function
A	Motor A
B	Motor B
C	Motor C
D	Motor Shield
E	Encoder 5V – power for encoder
F	Encoder A+ output
G	Encoder A- output
H	Encoder B+ output
J	Encoder B- output
K	Encoder Shield
L	12VDC - for limit, home, and temp sensor
M	DCCOM
N	Home – Switch to DCCOM when on forward side of home position
P	Not used
R	Not used
S	Chassis
T	Hall V+
U	Hall V-
V	Encoder Common
W	Encoder Index +
X	Encoder Index -
Y	Forward Limit Switch
Z	Reverse Limit Switch
a	Signal Shield
b	Hall A
c	Hall B
d	Temperature monitor – connect to DC Common for temperature OK
e	Hall C

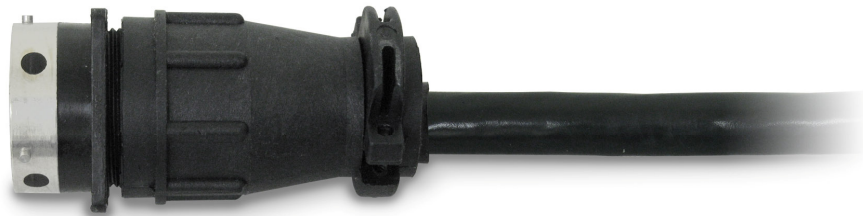

Table 7-2: Drive Encoder (EI option)

Pin	Function
1	Encoder Power, 5VDC
2	Encoder A+
3	Encoder B+
4	Encoder I+
5	Shield
6	Power Ground
7	Encoder A-
8	Encoder B-
9	Encoder I-



7.4.1) Color Codes for Pigtailed Cable

Cable consists of 3 independent shielded “pods”: One for motor signals, one for encoder signals & a 3rd for sensors and brake. Each of the pods is described below.

Cable 1

	Color	Function
■	Black	Motor R
■	Red	Motor S
□	White	Motor T
■	Shld	Motor Shield

Cable 2

	Color	Function
■	Red	Encoder 5V
□	White	Encoder A+ output
■	Yellow	Encoder A- output
■	Green	Encoder B+ output
■	Blue	Encoder B- output
■	Shld	Encoder Shield
■	Black	Encoder Common
■	Orange	Encoder Index +
■	Brown	Encoder Index -



Cable 3

	Color	Function
■	Green	12VDC
■	Blue	DCCOM
□	White	Home
□ / ■	Wht/Red	Brake release output (24VDC)
□ / ■	Wht/Black	Brake return
■	Shld	Chassis
■	Black	Hall V+
■	Brown	Hall V-
■	Violet	Forward Limit Switch
■	Gray	Reverse Limit Switch
■	Red	Hall A
■	Orange	Hall B
■	Tan	Temperature Monitor
■	Yellow	Hall C

7.4.2) Hall Effect Commutation Sequence

The following diagram shows the motor signal timing for the Servo Motor option

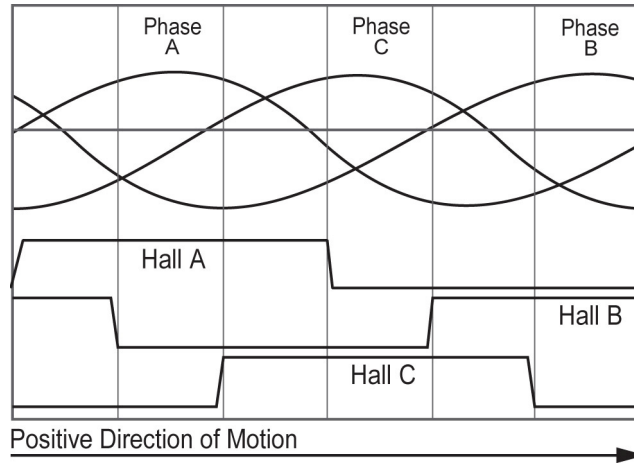

Figure 7-2: Motor commutation chart

The following diagram shows the encoder signal timing for the Encoder option

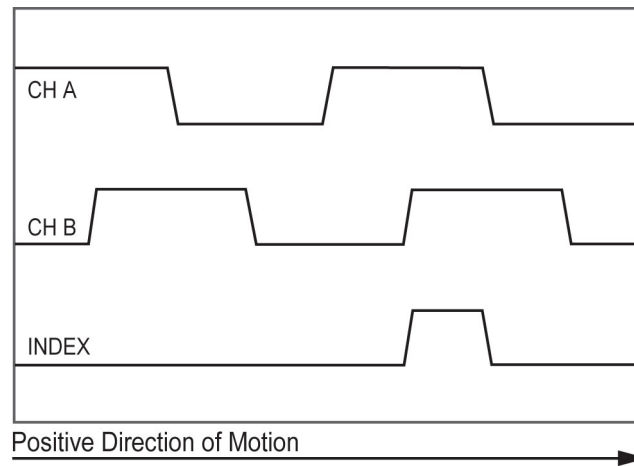

Figure 7-3: Timing diagram for the encoder signals

7.5) Home and Limit Sensors

Each PLR model includes Forward and Reverse Limit Switches. These are configured for Normally Closed or Normally Open at time of order. The PLR350 includes a Home Sensor that may also be ordered Normally Open or Normally Closed. The motors include an over temperature switch. Figure 7-4 shows the equivalent circuit for these sensors.

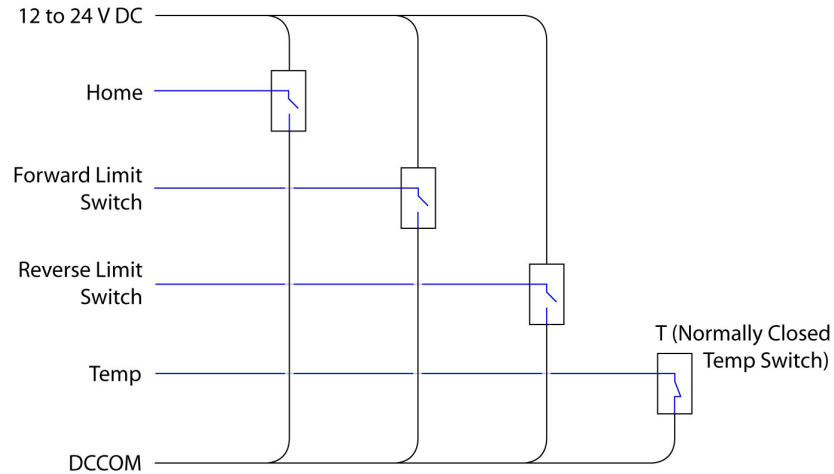

Figure 7-4: Equivalent Limit, Home, and Temp circuit schematic

7.5.1) Home Options:

The Home switch is ordered in either the Normally Closed (H1) or Normally Open (H2) configuration

H1: Switch is closed when platen is between the negative (reverse) end of travel and the home transition point. It is open from the transition point to forward end of travel.

H2: Switch is open when platen is between the negative (reverse) end of travel and the home transition point. It is closed from the transition point to forward end of travel.

7.5.2) Limit Options:

The Limit switches are ordered in either the Normally Closed (L1) or Normally Open (L2) configuration

L1: When the platen is in the normal operating range of travel, both limit switches are closed. When the platen encounters a limit the switch opens. The switch will close again when the platen is moved away from the switch.

L2: When the platen is in the normal operating range of travel, both limit switches are open. When the platen encounters a limit the switch closes. The switch will open again when the platen is moved away from the switch.

7.5.3) Limit Sensors and Reference Index

End of travel optical limit switches trigger when platen is rotated past its nominal travel of $\pm 5^\circ$ from center. A reference index on the encoder is located at the nominal center of travel. The limit switches and encoder index are fixed at the factory and cannot be adjusted. See Figure 7-5 for clarification.

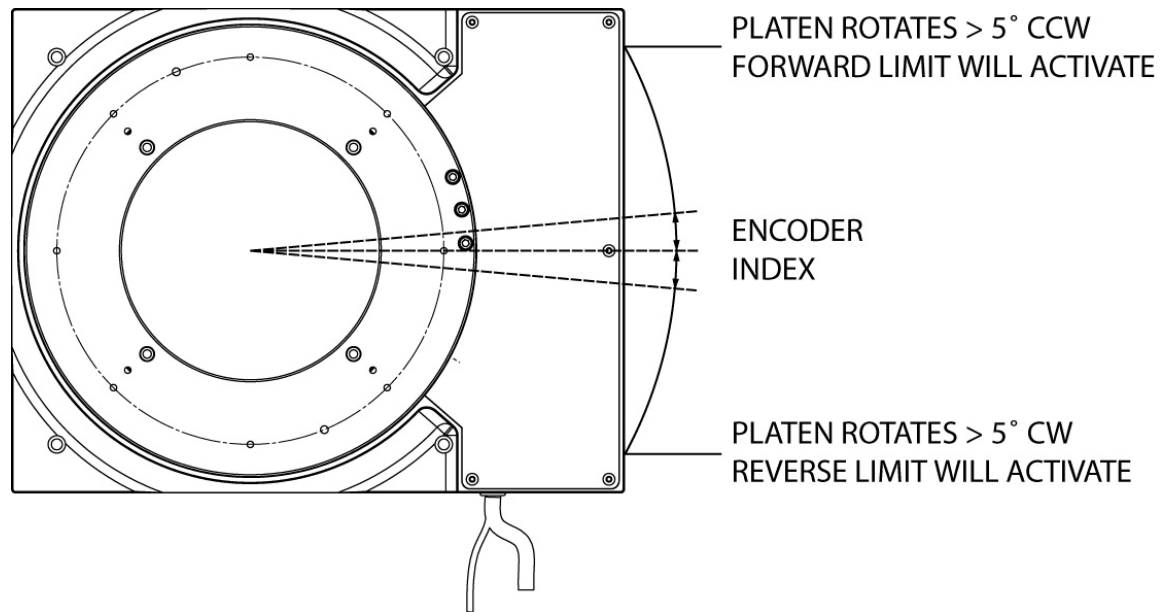

Figure 7-8: PLR350 Encoder Index & Limit Transitions

7.6) Recommended System Test

Before attaching a load or applying power to your stage, verify the encoder and limit switches are working properly. Move the stage carriage by hand in the positive direction and verify the encoder count is increasing (see Figure 4-1). Runaway conditions caused by miswired encoders can result in stage damage and personal injury. Move carriage to each end of travel to ensure limit switches are working properly. When closing the position loop for the first time, set the torque limit of your controller to a low value and use conservative tuning gains. Once the control loop is working properly, payloads can be added to the stage carriage.

8) Preventive Maintenance

Performing preventive maintenance procedures on your stage will extend its life and improve its long-term performance.

8.1) Lubrication

Use clean room grease to lubricate the ballscrew. We recommend NSK grease part #GRS LG2. For low duty cycle applications, it is recommended that the ballscrew be re-greased every six months. High duty cycle applications may require more frequent re-lubrication. Lubrication intervals depend on duty cycle, load and ambient conditions. Inspection of the drivetrain elements may be required to determine the proper lubrication interval. Primatics offers a grease kit that has all the necessary hardware to re-lubricate the ballscrew.

To gain access to the ballscrew assembly in the PLR350, remove the top cover with a Phillips Head Driver. Coat the ballscrew shaft with a thin coat of grease and wipe away any excess. Replace the top cover.

9) Troubleshooting & Service

9.1) Troubleshooting Help

For further assistance contact the factory:
M-F 8AM to 5PM Pacific Time

Phone:	[541] 791-9678
Fax:	[541] 791-9410
Toll Free:	[888] 754-3111
Web:	www.primatics.com
E-mail:	service@primatics.com

9.2) Service

Should your device require factory service, contact the factory for a Return Materials Authorization (RMA). When inquiring about an RMA please have the following information available:

- Your contact information (name, phone, email, address)
- Unit Serial Number (see Figure 9-1)
- Symptom of problem
- History of troubleshooting steps already taken

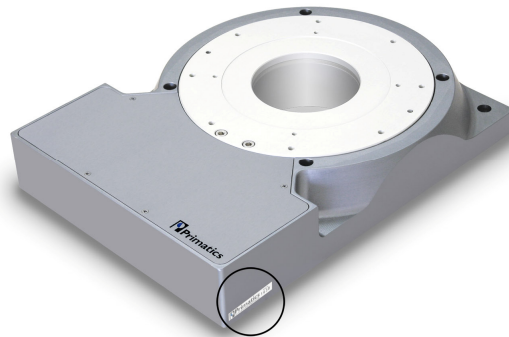

Figure 9-1: PLR350 S/N Location